

Article number: 03019006

Description: Fluro Rod End GIRSW 6-R
Housing and ball in stainless steel

Measures

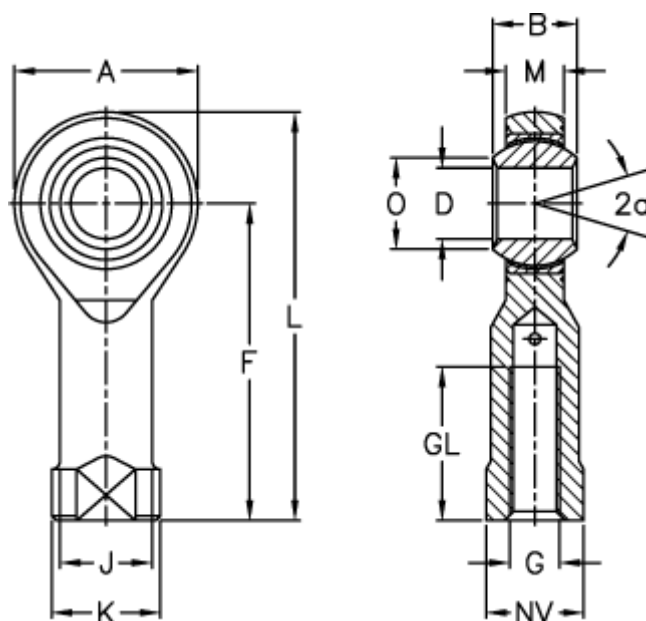

A	= 20	J	= 10	Weight (g) = 27
a (degrees)	= 13	K	= 13	
B	= 9	L	= 40	
D	= 6	M	= 6.75	
Dynamic load C (kN)	= 9.3	NV	= 11	
F	= 30	O	= 8.9	
G	= M6	Permissible rpm	= 530	
GL	= 12	Static load C0 (kN)	= 13.1	